



MR Miniature Linear Guide Series
ST Miniature Stroke Slide Series

* cpc RESERVES THE RIGHT TO REVISE ANY INFORMATION AT ANY TIME WITHOUT NOTICE.

cpc CHIEFTEK PRECISION Co., LTD.

HEADQUARTERS

CHIEFTEK PRECISION Co., LTD.

No.3, Dali 1st Rd., Sinshih Township,
Tainan Science Park, 741-45 Tainan, Taiwan, R.O.C
TEL:+886-6-505 5858 <http://www.chieftek.com>
E-mail:service@mail.chieftek.com

CHIEFTEK PRECISION USA

4881 Murietta Street,
Chino, CA, 91710
Tel: +1-909-438-9300
Fax: +1-909-428-7171

cpc Europa GmbH

Industriepark 314,
D-78244 Galtmadingen, Germany
TEL:+49-7731-59130-38
FAX:+49-7731-59130-28

CHIEFTEK MACHINERY KUNSHAN Co., LTD.

No. 1188, Hongjiao Rd., Kunshan,
Jiangsu, P.R. China
TEL:+86-512-5525 2831
FAX:+86-512-5525 2851



cpc CHIEFTEK PRECISION Co., LTD.

MR-02-O31-EN

Company Profile

Chieftek Precision has invested enormous resources into the research and development of high performance linear motion products.

cpc miniature linear guides were developed in 2000 as a key component for precision measurement and inspection instruments.

The semiconductor equipment, electronic and computer peripheral industries are growing. As these industries grow, demand has increased for the key components of automation that provide product miniaturization with high functionality.

cpc linear guides are used extensively in the machinery of today's modern technology, in such areas as semiconductor equipment, small machinery, robotics, fixtures, tools, consumer OA products, and high-priced computer peripheral equipment.

cpc is staffed by talented and experienced professionals. Our long-term goal is to become the market leader in linear motion components.



1998	Established
2000	Official production of miniature linear guides
2004	Production of miniature linear guide size MR3M
2005	Establishment of workshop in Tainan Science Park
2007	Production of AR/HR linear guides certified by ISO 9001:2000
2008	Established cpc USA Established cpc Kunshan in China Production of LM-PC Linear Motors
2010	Established cpc Europa GmbH
2010	Production of AR/HR linear guides certified by ISO 9001:2008
2011	cpc new factory is established. Production of miniature linear guide size MR2W



Product Line Include:
1. Miniature linear guide series
2. Standard linear guide series
3. Linear motor series

Table of Contents

MR Miniature Linear Guide series

1. Product Introduction	02
2. Technical Information	
2.1 Precision	07
2.2 Preload	08
2.3 Lubrication	09
2.4 Friction	12
2.5 Load capacity and rating life	13

3. Ordering Information	16
--------------------------------	----

4. Installation Illustration	18
-------------------------------------	----

5. Dimensions and Specifications

5.1 Standard MR-M SU/ZU series	20
5.2 Standard MR-M SS/ZZ series	22
5.3 Standard MR-M SUE/ZUE series	24
5.4 Standard MR-M EE/EZ series	26
5.5 Standard MR-M EU/UZ series	28
5.6 Standard MR-W SU/ZU series	30
5.7 Standard MR-W SS/ZZ series	32
5.8 Standard MR-W SUE/ZUE series	34
5.9 Standard MR-W EE/EZ series	36
5.10 Standard MR-W EU/UZ series	38
5.11 Standard MRU-M series - Tapped from bottom	40
5.12 Wide MRU-W series - Tapped from bottom	40

6. Carbon Steel	41
------------------------	----

ST Miniature Stroke Slide series

1. Product Introduction	44
2. Technical Information	46
3. Ordering Information	47
4. Dimensions and Specifications	48

AR/HR Series Lubrication Storage Testing Report	50
--	----

1. Product Introduction

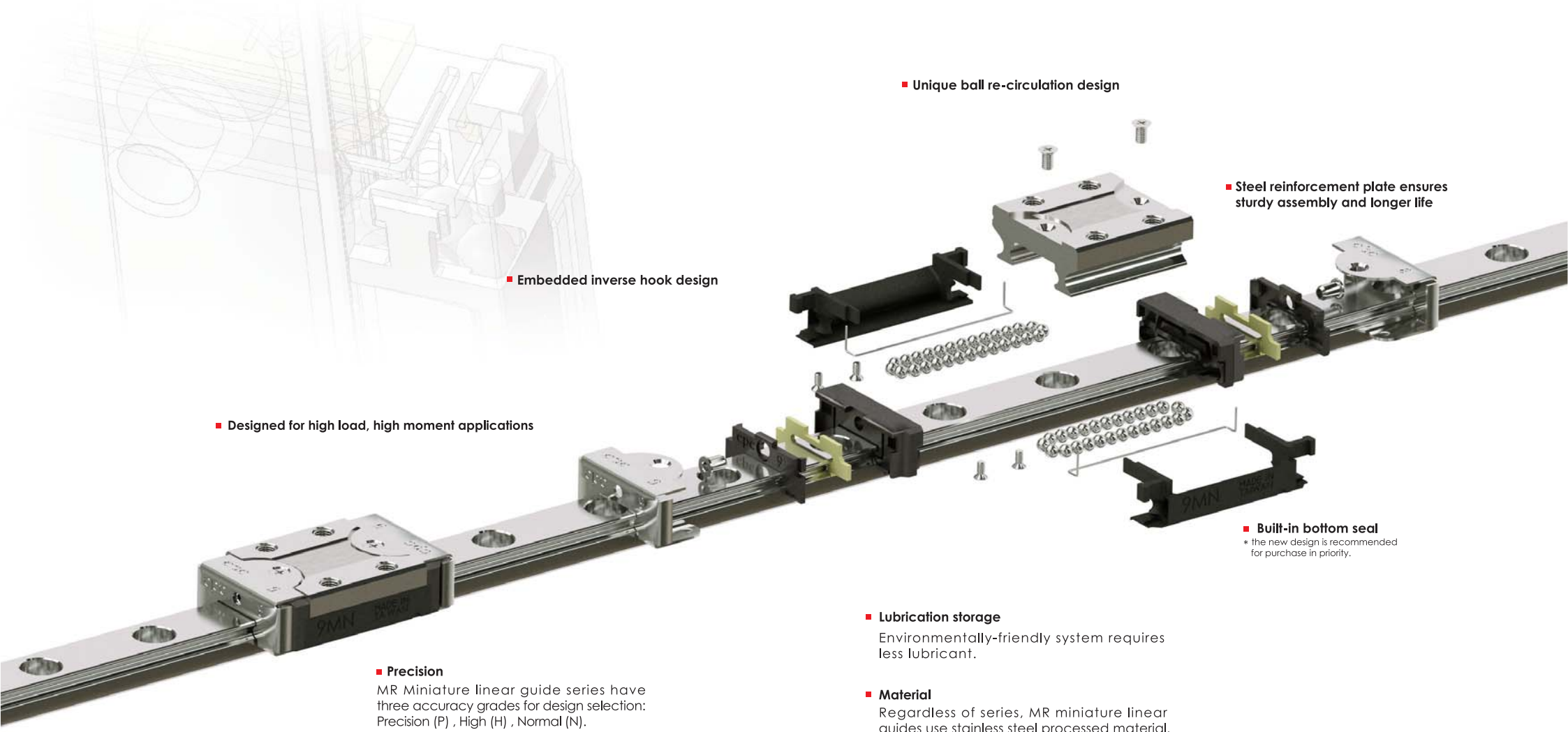

■ Embedded inverse hook design

■ Designed for high load, high moment applications

■ **Precision**

MR Miniature linear guide series have three accuracy grades for design selection: Precision (P) , High (H) , Normal (N).

■ Unique ball re-circulation design

■ Steel reinforcement plate ensures sturdy assembly and longer life

■ **Built-in bottom seal**
* the new design is recommended for purchase in priority.

■ **Lubrication storage**

Environmentally-friendly system requires less lubricant.

■ **Material**

Regardless of series, MR miniature linear guides use stainless steel processed material.

1. Product Introduction

Dustproof design

SS series-end seal

The standard end seal design can be hermetic and dustproof effectively; it can also maintain the product life, reduce lubrication grease consumption, and ensure a long-lasting lubrication effect. The special design of seal lip can generate few friction force without influencing its running smoothness.

Environmentally friendly lubrication design

ZZ series-end seal and lubrication pad

The two ends of the runner block are respectively provided with a hermetic lubrication grease injection design, capable of bringing the lubrication grease to the raceway by means of steel ball circulation, thereby achieving a lubrication effect. A built-in lubrication pad is optionally provided upon the design, further ensuring the lubrication effect of a long-term running, thereby reducing the maintenance cost, and further performing a very good lubrication capability during a short stroke running.

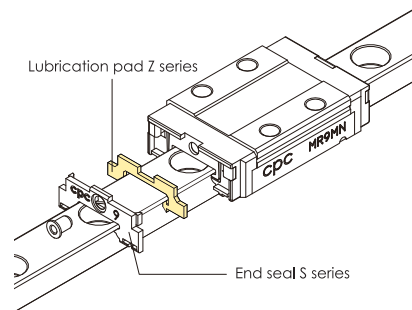

End reinforcing design

EE series-end seal and reinforcing plate

Adopting two pieces of stainless steel reinforcing plate to cover the two plastic ends of the slide block completely with an all cover design, and using stainless steel screws to respectively secure the upper and lower sides of the runner block steel body tightly strengthen the rigidity and coverage of the end cap so as to endure a faster running speed; a gap sealing design is adopted between the reinforcing plate and slide rail, allowing the stainless steel reinforcing plate to have a wiping blade function too.

Running speed $V_{max}=5m/s$ · $a_{max}=300m/s^2$
($60m/s^2$ can be reached without prepressing)

EZ series - end seal, reinforcing plate and lubrication pad

The built-in lubrication pads at the two ends of the runner block conform to environmental protection requirements and reduce maintenance cost.

EU series - end seal, stainless steel bottom seal and reinforcing plate

The stainless steel bottom seal protects the runner block of the EU series from the collision of foreign matters from the bottom and hence the damage of the runner block. Therefore, the runner block of this series has the best protection capability among all series; the product is recommended for using in the environment with enormous iron scraps around.

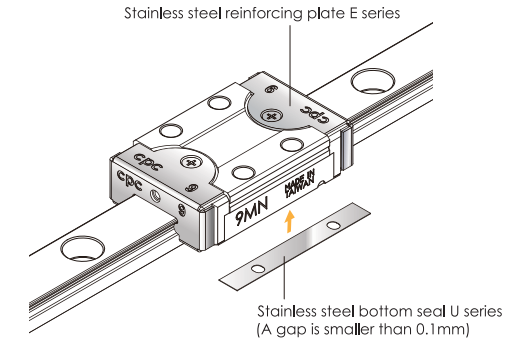

UZ series - end seal, stainless steel bottom seal, reinforcing plate and lubrication pad

The lubrication pad can provide highly rigid runner block with better lubrication and grease storage capabilities, and reduce re-greasing time.

Brand new U series

Features: the built-in bottom seal does not affect the friction resistance if a clearance is smaller than 0.1mm.

SU series - end, bottom seals

In addition to a normally equipped end seal, a newly designed runner block is equipped with an extra bottom seal, which can prevent foreign matters entering via the lower side of the runner block into the ball running rail, extending the working life of the runner block.

*the new design is recommended for purchase in priority.

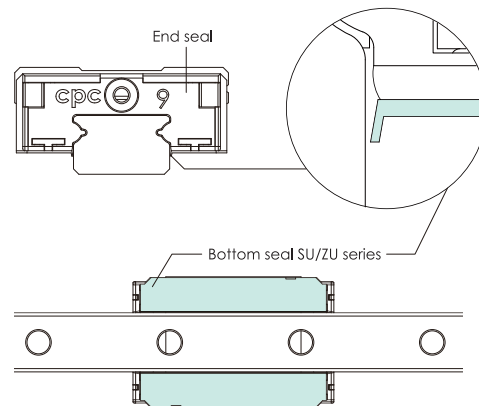

ZU series - end, bottom seals and lubrication pad

A newly designed bottom seal can prevent lubrication grease from spilling below the runner block. In addition, a built-in lubrication pad is mounted, further strengthening the effects of saving grease, and extending a re-greasing interval.

*the new design is recommended for purchase in priority.

Brand new UE series

SUE series - end seal, bottom seal and reinforcing plate

Built-in type bottom seal strengthens the dustproof capability of the bottom of the runner block, and the stainless steel reinforcing plate can prevent hard and rigid objects from striking by the plastic cap out of the end; its dustproof effect is the best among all the product series.

*the new design is recommended for purchase in priority.

ZUE series - end seal, bottom seal, reinforcing plate and lubrication pad

The bottom seal can prevent the lubrication grease from spilling below the runner block, and an built-in lubrication pad is further mounted, further strengthening a grease saving effect.

*the new design is recommended for purchase in priority.

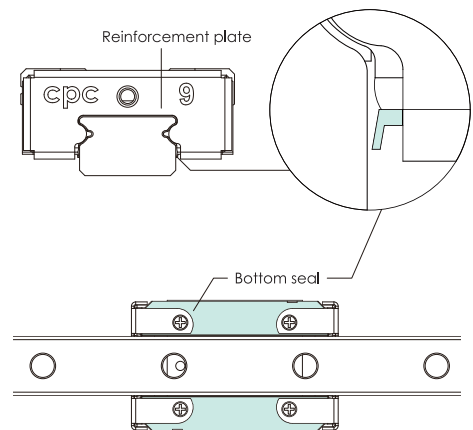

1. Product Introduction

Embedded inverse hook design for reinforced mechanical integration

When the runner block is in motion and changing direction, the circulating stainless steel balls inside the raceway generate impact force against the plastic end cap. As the demand for rapid motion in the automation industry has increased, **cpc** has invented a new design to improve high speed running capability. Plastic inverse hooks for miniature linear blocks tightly secure block components to handle the impact force effectively by distributing the applied stress over a larger area.

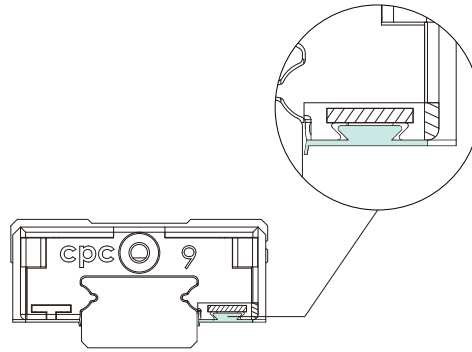

Brand new design

Suitable for:
 High speed belt driven mechanism
 High speed carrier design
 Automation linkage between stations

High load and high moment capacity

The MR Miniature Linear Guide series is designed using two rows of recirculating balls. The design uses a Gothic profile with a 45° contact angle to achieve equal load capacity in all directions. Within the restriction of limited space, larger stainless steel balls are used to enhance the load and torsion resistance capacity.

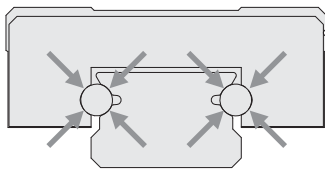

Dust Proof Design

Our standard design comes equipped with an end seal that effectively restricts dust contamination and prolongs lubrication, ensuring longer product life. Specially-designed low friction seal lips do not affect running smoothness.

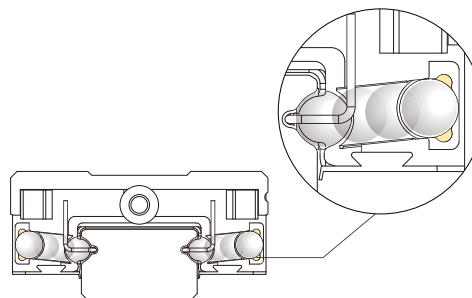

cpc linear guides (indicated with the thick black line above) provide greater surface contact as compared to competing products (indicated with the red-dotted line) when comparing same width rails.

2. Technical Information

2.1 Precision

Accuracy

MR Miniature Linear Guide series have three accuracy grades (P,H,N) for your choice.

	Table of accuracy			
		Precision	High	Normal
		P	H	N
Tolerance of dimension height H	H	± 10	± 20	± 40
Variation of height for different runner Block on the same position of Rail	ΔH	7	15	25
Tolerance of dimension width W	W ₂	± 15	± 25	± 40
Variation of width for different runner Block on same position of Rail	ΔW ₂	10	20	30

Speed

The maximum speed for the standard MR-SS/ZZ,SU/ZU type is:
V_{max} = 3 m/s

Maximum acceleration
a_{max} = 250 m/s²
 (If preload V0, capable of reaching 40m/s²)

The maximum speed for the standard MR-EE/EZ,EU/UZ,SUE/ZUE type is:
V_{max} > 5 m/s

Maximum acceleration **a_{max} = 300 m/s²**
 (If preload V0, capable of reaching 60m/s²)

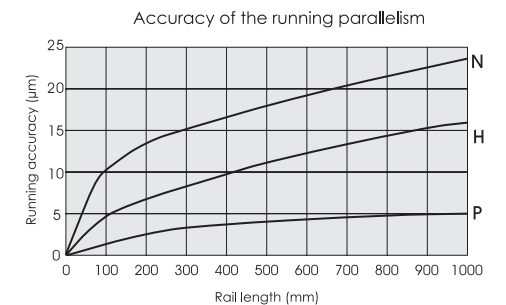

2. Technical Information

2.2 Preload

Preload

The MR Miniature Linear Guide series have three degrees of preload: V0, VS and V1 (as described in the table of preload below.) Preload can enhance stiffness, precision, and torsion resistance, but will negatively affect life and friction.

Table of Preload

Preload type	Model code	Clearance (um)						Application
		3	5	7	9	12	15	
Clearance	V0	+3-0	+3-0	+4-0	+4-0	+5-0	+6-0	Very smooth
Standard	VS	+1-0	+1-0	+2-0	+2-0	+2-0	+3-0	Smooth and precision
Light preload	V1	0--0.5	0--1	0--3	0--4	0--5	0--6	High rigidity Minimize vibration High precision Load balance

Operating Temperature

The MR Miniature Linear Guide can operate in a range of temperatures from -40°C~ +80°C. For short term operation, it can reach up to +100°C.

2.3 Lubrication

Function

The loaded rolling elements and the raceway will be separated at the contact zone by a thin layer of oil. The lubrication will therefore:

- Reduce friction
- Reduce corrosion
- Reduce wear
- Dissipate heat and increase service life

Lubrication Caution

- ZZ/ZU/EZ/UZ/ZUE Lubrication Storage Series
 1. Block contains with lubricant which can directly install on the machine and no need to be washed.
 2. If washing the blocks, please do not soak the block in the lubricant before both the detergent of lubrication storage and Cleaning Naphtha are totally dry. The block is ready for installation only on the condition that the lubrication storage is full of the lubricant.
- The linear guide must be lubricated for protection before first time use. Pollution of any kind should be avoided.
- The runner block should be moved back and forth during lubrication.
- Generally, the lubricant is added onto the rail raceway.
- The lubricant can be injected into the lubrication holes on either end of the runner block.
- A thin layer of lubricant should be maintained on the surface of the rail raceway.
- Re-lubricate before contamination or discoloration of the lubricant occurs.
- Please notify when used in acidic, alkaline, or clean room applications.
- Contact our technical department for lubrication assistance if the runner block is used in a wall mount configuration.
- The re-lubrication interval must be shortened if the travel stroke is < 2 or > 15 times the length of the steel body of the runner block.

Grease lubrication

When grease lubrication is used, we recommend synthetic oil-based lithium soap grease with a viscosity between ISO VG32-100.

Oil lubrication

We recommend the synthetic oils CLP or CGLP (based on DIN 51517) or HLP (based on DIN 51524) with a viscosity range between ISO VG32-100 for working temperatures between 0°C~+70°C. (We recommend ISO VG10 for use in lower temperature environments.)

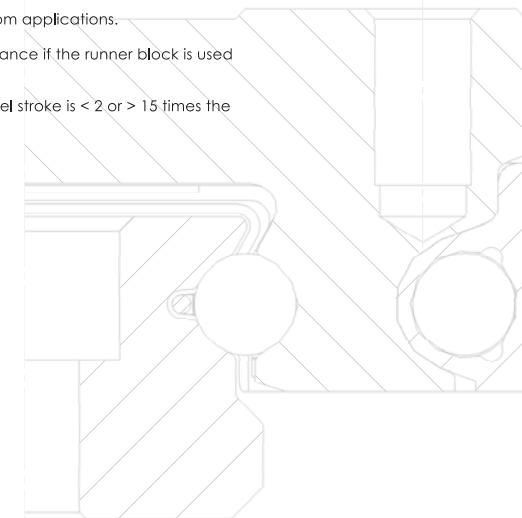

2. Technical Information

2.3 Lubrication - continued

Re-lubrication

- Re-lubrication shall be applied before the lubricant in the block is contaminated or changes color.
- The amount of the lubricant applied should be 1/2 of the first lubrication.
- Re-lubrication shall be applied under operating temperature with the runner block moved back and forth.
- If the stroke is smaller than twice or greater than 15 times the steel body length of the block, the re-lubrication interval shall be shortened.

Table 1

Model code	First lubrication (cm ³)	Model code	First lubrication (cm ³)
-	-	2 WL	0.03
3 MN	0.02	3 WN	0.03
3 ML	0.03	3 WL	0.04
5 MN	0.03	5 WN	0.04
5 ML	0.04	5 WL	0.05
7 MN	0.12	7 WN	0.19
7 ML	0.16	7 WL	0.23
9 MN	0.23	9 WN	0.30
9 ML	0.30	9 WL	0.38
12 MN	0.41	12 WN	0.52
12 ML	0.51	12 WL	0.66
15 MN	0.78	15 WN	0.87
15 ML	1.05	15 WL	1.11

Re-lubrication Interval

The speed, load, stroke length and operating environment affect the re-lubrication interval. A safe re-lubrication interval can only be obtained by practical observation. However, the re-lubrication interval shall not exceed one year. Lubrication can be applied through the injection hole on both ends of the runner block by using a special injector offered by **cpc**.

Lubrication grease

- 00 For general applications
- 01 For low-friction, low-noise applications
- 02 For clean room applications
- 03 For clean room and vacuum environment applications
- 04 For high-speed applications
- 05 For micro-oscillation applications

Lubrication oil

- 11 For general applications, ISO V32-68

Ordering of the lubrication injector

LUB - 01 - 18G	
Lubricant :	Needle model :
00	21G: 5M/5W
01	19G: 7M/7W
02	18G: 9M/9W
03	18G: 12M/12W
04	15G: 15M/15W
05	
11	

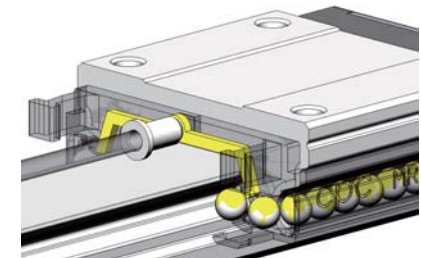

Lubricant amount: 10ml



2. Technical Information

2.4 Friction

Friction

The MR Miniature Linear Guide series has low-friction characteristics with a stable and minor starting friction.

Sealing Design

The MR Miniature Linear Guide series are enclosed by end seals on both ends of the runner block. Optional side seals create an all-around sealing system.

	Friction	Friction of End Seal under Lubrication		
		MR size	Friction of End Seal (Nmax) (under lubrication)	
			M	W
$F_m = \mu \cdot F$	—(1)	2	0.08	0.2
F	Load (N)	3	0.08	0.2
F_m	Friction (N)	5	0.08	0.2
		7	0.1	0.4
		9	0.1	0.8
		12	0.4	1.0
		15	1.0	1.0

MR Miniature Linear Guide series friction factor is $\mu = 0.002 \sim 0.003$ approximately

Factors of friction

- Sealing system.
- Collision between the balls during operation.
- Collision between the balls and the return path.
- Number of balls in the Gothic arch load zone.
- Resistance from churning of the lubricant in the runner block.
- Contaminants.

2.5 Load capacity and rating life

Static load rating C

For the static load traveling along the acting direction, the maximum calculated stress at the rolling elements and the raceway, by a curvature radius ≤ 0.52 , is 4200 MP a and, by a curvature radius ≤ 0.6 , is 4600 MP a.

Note: Under such stress, a permanent total deformation is generated at this contact point corresponding to about 0.0001 times the rolling element diameter.
(The above is according to ISO 14728-2)

Static load safety factor calculation			
$S_0 = C_0 / P_0$	—(11)	Operation condition	S_0
$S_0 = M_0 / M$	—(12)	Normal operation	1 ~ 2
$P_0 = F_{max}$	—(13)	Load with vibration or impact	2 ~ 3
$M_0 = M_{max}$	—(14)	High accuracy and smooth running	≥ 3

Static load P_0 and moment M_0

Permissible static load and applied static load of the MR Miniature Linear Guide series is limited as follows:

- Static load of the linear guide.
- Permissible load of fixing screws.
- The permissible load of the related parts of the mechanism.
- The static load safety factor required for the application.

The equivalent static load and static moment are the largest load and moment, calculated by formulas (13) and (14).

Static load safety factor S_0

Under the static load safety factor, the linear guide system demonstrates reliable operation and running accuracy as required by the application. The static load safety factor S_0 is calculated by formulas (11) and (12).

- S_0 static load safety factor
- C_0 basic static load in acting direction N
- P_0 equivalent static load in acting direction N
- M_0 basic static moment in acting direction Nm
- M equivalent static moment in acting direction Nm

2.5 Load capacity and rating life - continued

Dynamic load rating C

When the dynamic loads are applied normal to the load zones with constant magnitude and direction, theoretically, the rating life of a linear guide can reach 100km of travel distance. (The above is according to ISO 14728-1).

Rating life calculation

$$C_{508} = 1.26 \cdot C_{1008} \quad (2)$$

$$C_{1008} = 0.79 \cdot C_{508} \quad (3)$$

$$L = \left(\frac{C_{1008}}{P} \right)^3 \cdot 10^5 \quad (4)$$

$$L_h = \frac{L}{2 \cdot s \cdot n \cdot 60} = \frac{L}{v_m \cdot 60} \quad (5)$$

L	= Rating life for travel distance 100,000 meter	(m)
L_h	= Rating life in hours	(h)
C_{1008}	= Dynamic load rating	(N)
P	= Equivalent load	(N)
s	= Length of stroke	(m)
n	= Stroke repetition	(min ⁻¹)
v_m	= Average speed	(m/min)

Rating Life L

An individual Linear Guide or a batch of identical Linear Guides under the same running conditions, using common materials with normal manufacturing quality and operating conditions can reach a 90% survival rate at the calculated life. (The above is according to ISO 14728-1.) When the standard of 50km travel distance is used, the dynamic load rating will exceed the value based on the standard ISO 14728-1 by 20% or more. The relationship between two load ratings is based on formula (2).

Calculation of rating life

Formulas (4) and (5) can be used when the equivalent dynamic load and the average speed are constant.

Equivalent dynamic load and speed

If the load and speed are not constant, each actual load and speed must be taken into account and both will influence life expectancy.

Equivalent dynamic load

If there is a change in load only, the equivalent dynamic load can be calculated according to formula (6).

Equivalent speed

If there is a change in speed only, the equivalent speed can be calculated using formula (7).

If there are changes in both the load and speed, the equivalent dynamic load can be calculated using formula (8).

Equivalent load capacities and speed calculation

$$P = 3 \sqrt{\frac{q_1 \cdot F_1^3 + q_2 \cdot F_2^3 + \dots + q_n \cdot F_n^3}{100}} \quad (6)$$

$$\bar{v} = \frac{q_1 \cdot v_1 + q_2 \cdot v_2 + \dots + q_n \cdot v_n}{100} \quad (7)$$

$$P = 3 \sqrt{\frac{q_1 \cdot v_1 \cdot F_1^3 + q_2 \cdot v_2 \cdot F_2^3 + \dots + q_n \cdot v_n \cdot F_n^3}{100 \bar{v}}} \quad (8)$$

$$P = |F_x| + |F_y| \quad (9)$$

$$P = |F| + |M| \cdot \frac{C_0}{M_0} \quad (10)$$

P	= Equivalent dynamic load	(N)
q	= Percentage of stroke	(%)
F_i	= Discrete load steps	(N)
\bar{v}	= Average speed	(m/min)
v	= Discrete speed steps	(m/min)
F	= External dynamic load	N
F_y	= External dynamic load, vertical	N
F_x	= External dynamic load, horizontal	N
C_0	= Static load rating	N
M	= Static moment	Nm
M_0	= Static moment in direction of action	Nm

Combined dynamic load

If the linear guide takes on load from an arbitrary angle, its equivalent dynamic load rating is calculated using formula (9).

Combined load in combination with a moment

If both load and moment act on the linear guide, the equivalent dynamic load can be calculated by the formula (10). According to ISO 14728-1, the equivalent load (P) shall not exceed 1/2C.

3. Ordering Information

3.1 Length of Rail

Length of Rail

Butt-jointing is required when lengths exceed Lmax. (For detailed information, please contact cpc technical support.)

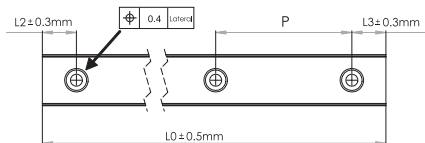

Model Code											Unit: mm						
MR	U	15	M	N	K	EE	2	V1	P	-310L	-15	-15	II	J	Customization code		
														Number of rails on the same moving axis			
														End hole pitch (mm)			
														Starting hole pitch (mm)			
														Rail length (mm)			
														Accuracy Grades: P(Precision) \ H(High) \ N(Normal)			
														Preload classes : V0 : Clearance VS : Standard V1 : Light Preload			
														Block quantity : Quantity of the runner block			
														SS: With End Seal ZZ: End seal + Lubrication Storage SU: End seal + Bottom Seal ZU: End seal + Bottom Seal + Lubrication Storage EE: End seal + Reinforcement Plate EZ: End seal + Reinforcement Plate + Lubrication Storage EU: End seal + Reinforcement Plate + Stainless Bottom Seal UZ: End seal + Reinforcement Plate + Stainless Bottom Seal + Lubrication Storage SUE: End seal + Bottom Seal + Reinforcement Plate ZUE: End seal + Bottom Seal + Reinforcement Plate + Lubrication Storage			
														Rail material : No Mark : Standard Rail K : Carbon steel (Now available: size 9, 12, and 15.)			
														Block type : L : Long N : Standard			
														Rail type : M : Standard W : Wide			
														Rail dimension : The width of rail ex. : 2 \ 3 \ 5 \ 7 \ 9 \ 12 \ 15			
														Special Rail U : Upward Screwing Rail No Mark : Standard Rail			
Product Type: MR: Miniature Linear Guide																	

Standard type	Unit: mm					
size	3M	5M	7M	9M	12M	15M
Standard length of one rail	30	40	40	55	70	70
	40	55	55	75	95	110
	50	70	70	95	120	150
		85	85	115	145	190
		100	100	135	170	230
			130	155	195	270
				175	220	310
				195	245	350
				275	270	390
				375	320	430
				370	470	
				470	550	
				570	670	
					870	
Pitch	10	15	15	20	25	40
L2, L3min.	3	3	3	4	4	4
L2, L3max.	5	10	10	20	20	35
L0 max.	300	1000	1000	1000	1000	1000

Wide type	Unit: mm						
size	2W	3W	5W	7W	9W	12W	15W
Standard length of one rail	30	40	50	50	50	70	110
	40	55	70	80	80	110	150
	50	70	90	110	110	150	190
			110	140	140	190	230
			130	170	170	230	270
			150	200	200	270	310
			170	260	260	310	430
				290	290	390	550
					320	470	670
						550	790
Pitch	10	15	20	30	30	40	40
L2, L3min.	3	3	4	3	4	4	4
L2, L3max.	5	10	15	25	25	35	35
L0 max.	300	1000	1000	1000	1000	1000	1000

Customization Requirement

The meaning of suffix characters:

- J : Butt-jointing track rail
- G : Customer designated lubricant
- I : Inspection report

- R : Special process for rail
- B : Special process for block
- S : Special straightness for rail

- C3 : Cap M3
- C4 : Cap M4
- MS : Metal Stopper on stainless steel Rail

J : Butt-Jointing track rail

When the required length of rail exceeds the standard rail length, a butt-joint can be specified. The rail butt-joint indication is marked as illustrated below.



B : Special process for block

For special process requirements, please contact technical support.



I : Inspection report

Please contact technical support.

S : Special straightness for rail

The straightness of the linear guide rail is specially calibrated by precision fine grinding.

MS : Metal Stopper on stainless steel Rail

- To prevent the block from separating from the rail during the transportation or the installation which may cause the item damaged or even scattered.
- Perfect plus for the rail installed on the vertical axis (Z axis) to prevent the block separates from the rail due to the gravity.
- Stoppers and the screws are made of stainless steel material with anti-corrosion function.
- Strongly NOT recommended being applied as the mechanical limited stopper.



R : Special process for rail

For special process requirements, please contact technical support.



G : Customer designated lubricant

According to application environment.

GN : No lubricant

GC : Low dust generation

Suitable for clean room environments.

C3 CapM3 :

Applies to MR9M, MR12M, MR15M, MR7W & MR9W rails.

C4 CapM4 :

Applies to MR12W, MR15W rails.



Dimension

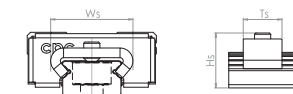

Rail Size	Ws max	Ts	Hs max
MR-7M	10	5	8
MR-9M	13	6	9
MR-12M	17	7	12
MR-15M	19	7	14
MR-7W	18	6	9
MR-9W	23	6	11
MR-12W	29	7	13
MR-15W	47	7	14

4. Installation Illustration

Height and chamfer of reference edge

To avoid any interference, the corner of the reference edge should have a chamfer. If not, please refer to the following table for the height of the reference edge corner and the height of the reference edge.

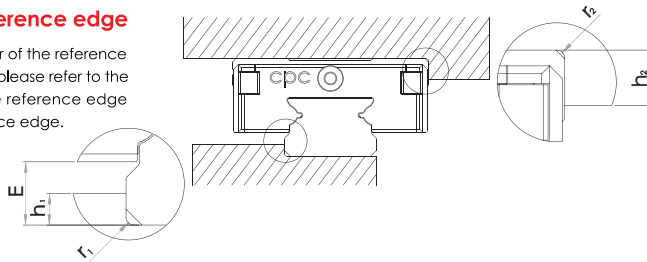

Height and chamfer of reference surface

Dimension	h2	r2max	r1max	SS/ZZ		SU/ZU		EE/EZ		EU/UZ		SUE/ZUE	
				h1	E	h1	E	h1	E	h1	E	h1	E
3M	1.5	0.3	0.1	0.8	1	0.6	0.9	-	-	-	-	-	-
5M	1.9	0.3	0.2	1.2	1.5	0.9	1.2	0.8	1.1	-	-	0.7	1.0
7M	2.8	0.3	0.2	1.2	1.5	0.8	1.1	-	-	-	-	-	-
9M	3	0.3	0.2	1.8	2.2	1.3	1.7	1.3	1.7	1	1.4	1.1	1.5
12M	4	0.5	0.3	2.6	3	2.1	2.5	1.9	2.3	1.6	2	1.7	2.1
15M	4.5	0.5	0.3	3.6	4	2.7	3.1	2.8	3.2	2.5	2.9	2.4	2.9

Dimension	h2	r2max	r1max	SS/ZZ		SU/ZU		EE/EZ		EU/UZ		SUE/ZUE	
				h1	E	h1	E	h1	E	h1	E	h1	E
2WL	1.5	0.3	0.1	0.8	1	0.6	0.9	0.5	0.7	-	-	0.4	0.6
3W	1.7	0.3	0.1	0.7	1	0.6	0.9	-	-	-	-	-	-
5W	2	0.3	0.2	1.2	1.5	1	1.3	-	-	-	-	-	-
7W	2.8	0.3	0.2	1.7	2	1.3	1.6	1.2	1.5	-	-	1.1	1.4
9W	3	0.3	0.2	3	3.4	2.5	2.9	2.4	2.8	2.1	2.5	2.2	2.6
12W	4	0.5	0.3	3.5	3.9	2.9	3.3	2.9	3.3	2.4	2.8	2.4	2.8
15W	4.5	0.5	0.3	3.6	4	3	3.4	2.8	3.2	2.4	2.8	2.4	2.8

Screw tightening torque (Nm)

Screw grade 12.9 Alloy Steel Screw	Steel		Non Iron Metal	ISO 3506-1 A2-70 Stainless Screw	Cast Iron
	Steel	Cast Iron	Non Iron Metal		Cast Iron
M2	0.6	0.4	0.3	M1.6	0.15
M2.5/M2.6	1.2	0.8	0.6	M2	0.3
M3	1.8	1.3	1	M2.5/M2.6	0.6
M4	4	2.5	2	M3	1.1
				M4	2.5

The mounting surface

Surface roughness
The mounting surface should be ground or fine milled to reach a surface roughness Ra1.6 μm.

Geometric and positional accuracy of the mounting surface

Inaccurate mounting surfaces will affect the operational accuracy of the linear guide when the mounting surface height differential is greater than the values calculated by formulas (15), (16), and (17). The rating lifetime will also be shortened.

e1 (mm) = b (mm) · f1 · 10⁻⁴ — (15)

e2 (mm) = d (mm) · f2 · 10⁻⁵ — (16)

e3 (mm) = f3 · 10⁻³ — (17)

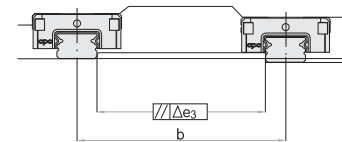

Reference edge

Rail: Both sides of the track rail can be the reference edge without any special marking.
Block: Reference edge is opposite to the groove marking side.

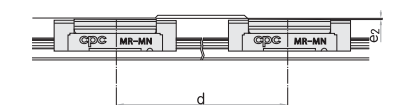

Dimension	V0/VS			V1		
	f1	f2	f3	f1	f2	f3
3MN	4	9	2	3	9	1
5MN	4	8	2	2	8	2
7MN	5	11	4	3	10	3
9MN	5	11	6	4	10	4
12MN	6	13	8	4	12	6
15MN	7	11	12	5	10	8
3ML	4	5	2	3	5	1
5ML	3	5	2	2	5	1
7ML	4	6	4	3	6	3
9ML	5	7	5	3	7	4
12ML	5	8	8	3	7	5
15ML	7	8	11	4	8	7

Dimension	V0/VS			V1		
	f1	f2	f3	f1	f2	f3
2WL	4	5	2	3	5	1
3WN	2	5	2	4	3	1
5WN	2	5	2	1	3	1
7WN	2	6	4	2	4	3
9WN	2	7	6	2	5	4
12WN	3	8	8	2	5	5
15WN	2	9	11	1	6	7
3WL	2	3	1	1	2	1
5WL	2	3	2	1	2	1
7WL	2	4	4	1	3	3
9WL	2	5	5	2	3	3
12WL	2	5	7	2	3	5
15WL	2	5	10	1	4	7

5. Dimensions and Specifications

5.1 MR-M SU Series (End seal , Bottom Seal)

MR-M ZU Series (End seal , Bottom Seal , Lubrication Storage)

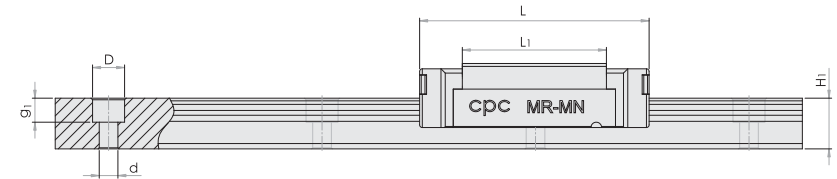
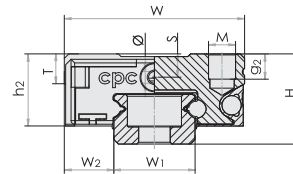

Model Code	Fabricate Dimensions		Rail Dimension(mm)				Block Dimension(mm)						Block Dimension(mm)				Load Capacities(N)		Static Moment(Nm)			Weight		Model Code
	H	W ₂	W ₁	H ₁	P	D x d x g ₁	W	L	L ₁	h ₂	P ₁	P ₂	M x g ₂	∅	S	T	C ₁₀₀₈ (dyn)	C ₀ (stat)	M _{r0}	M _{p0}	M _{y0}	Block(g)	Rail(g/m)	
MR 15ML SU/ZU	16	8.5	15	9.5	40	6x3.5x4.5	32	60	44	12.3	25	25	M3x5.5	1.8	3.3	4.3	5350	9080	70	63.3	63.3	90	930	MR 15ML SU/ZU
MR 15MN SU/ZU	16	8.5	15	9.5	40	6x3.5x4.5	32	43	27	12.3	20	25	M3x5.5	1.8	3.3	4.3	3810	5590	43.6	27	27	61	930	MR 15MN SU/ZU
MR 12ML SU/ZU	13	7.5	12	7.5	25	6x3.5x4.5	27	47.6	34	10.2	20	20	M3x3.5	1.3	3.2	4.3	3240	5630	34.9	30.2	30.2	51	602	MR 12ML SU/ZU
MR 12MN SU/ZU	13	7.5	12	7.5	25	6x3.5x4.5	27	35.4	22	10.2	15	20	M3x3.5	1.3	3.2	4.3	2308	3465	21.5	12.9	12.9	34	602	MR 12MN SU/ZU
MR 9ML SU/ZU	10	5.5	9	5.5	20	6x3.5x3.5	20	40.9	30.8	8	16	15	M3x3.0	1.3	2.2	3.3	2135	3880	18.2	12.4	12.4	28	301	MR 9ML SU/ZU
MR 9MN SU/ZU	10	5.5	9	5.5	20	6x3.5x3.5	20	30.6	20.5	8	10	15	M3x3.0	1.3	2.2	3.3	1570	2495	11.7	6.4	6.4	18	301	MR 9MN SU/ZU
MR 7ML SU/ZU	8	5	7	4.7	15	4.2x2.4x2.3	17	31.2	21.8	6.7	13	12	M2x2.5	1.1	1.6	2.8	1310	2440	9	7.7	7.7	14	215	MR 7ML SU/ZU
MR 7MN SU/ZU	8	5	7	4.7	15	4.2x2.4x2.3	17	23.7	14.3	6.7	8	12	M2x2.5	1.1	1.6	2.8	890	1440	5.2	3.3	3.3	8	215	MR 7MN SU/ZU
MR 5ML SU/ZU	6	3.5	5	3.5	15	3.5x2.4x1	12	19.6	13.5	4.6	7	-	M2.6x2.0	0.7	1.3	2	470	900	2.4	2.1	2.1	4	116	MR 5ML SU/ZU
MR 5MN SU/ZU	6	3.5	5	3.5	15	3.5x2.4x1	12	16	10	4.6	-	8	M2x1.5	0.7	1.3	2	335	550	1.7	1	1	3.5	116	MR 5MN SU/ZU
MRU 3ML SU/ZU	4	2.5	3	2.6	10	M1.6	8	16	11	3.1	5.5	-	M2x1.1	0.3	0.7	1.5	295	575	0.9	1.1	1.1	1.2	53	MRU 3ML SU/ZU
MRU 3MN SU/ZU	4	2.5	3	2.6	10	M1.6	8	11.7	6.7	3.1	3.5	-	M1.6x1.1	0.3	0.7	1.5	190	310	0.6	0.4	0.4	0.9	53	MRU 3MN SU/ZU

* Anticipated

Load capacities are calculated according to ISO 14728. To compare the rating life definition and the load capacities: C₅₀₈=1.26xC₁₀₀₈

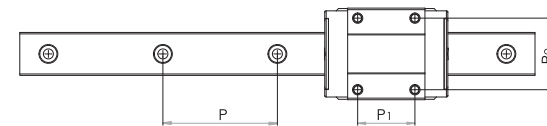
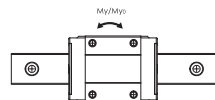
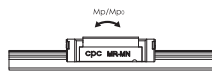
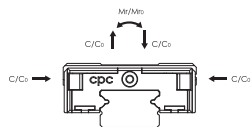

5. Dimensions and Specifications

5.2 MR-M SS Series (End seal)

MR-M ZZ Series (End seal , Lubrication Storage)

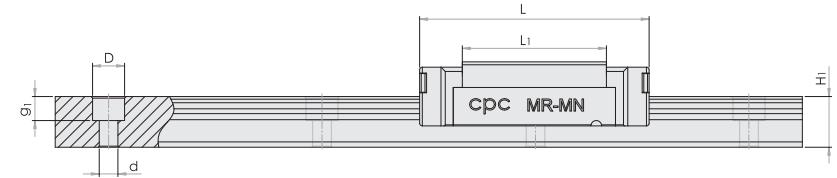
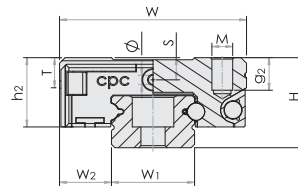

Model Code	Fabricate Dimensions		Rail Dimension(mm)				Block Dimension(mm)						Block Dimension(mm)				Load Capacities(N)		Static Moment(Nm)			Weight		Model Code
	H	W2	W1	H1	P	D x d x g1	W	L	L1	h2	P1	P2	M x g2	∅	S	T	C1008 (dyn)	Co (stat)	Mr0	Mp0	My0	Block(g)	Rail(g/m)	
MR 15ML SS/ZZ	16	8.5	15	9.5	40	6x3.5x4.5	32	60.1	44	12	25	25	M3x5.5	1.9	3.3	4.3	5350	9080	70	63.3	63.3	90	930	MR 15ML SS/ZZ
MR 15MN SS/ZZ	16	8.5	15	9.5	40	6x3.5x4.5	32	43.1	27	12	20	25	M3x5.5	1.9	3.3	4.3	3810	5590	43.6	27	27	61	930	MR 15MN SS/ZZ
MR 12ML SS/ZZ	13	7.5	12	7.5	25	6x3.5x4.5	27	47.6	34.1	10	20	20	M3x3.5	1.4	3.2	4.3	3240	5630	34.9	30.2	30.2	51	602	MR 12ML SS/ZZ
MR 12MN SS/ZZ	13	7.5	12	7.5	25	6x3.5x4.5	27	35.4	22	10	15	20	M3x3.5	1.4	3.2	4.3	2308	3465	21.5	12.9	12.9	34	602	MR 12MN SS/ZZ
MR 9ML SS/ZZ	10	5.5	9	5.5	20	6x3.5x3.5	20	41	30.8	7.8	16	15	M3x3.0	1.3	2.2	3.3	2135	3880	18.2	12.4	12.4	28	301	MR 9ML SS/ZZ
MR 9MN SS/ZZ	10	5.5	9	5.5	20	6x3.5x3.5	20	30.8	20.5	7.8	10	15	M3x3.0	1.3	2.2	3.3	1570	2495	11.7	6.4	6.4	18	301	MR 9MN SS/ZZ
MR 7ML SS/ZZ	8	5	7	4.7	15	4.2x2.4x2.3	17	31.5	21.8	6.5	13	12	M2x2.5	1.2	1.6	2.8	1310	2440	9	7.7	7.7	14	215	MR 7ML SS/ZZ
MR 7MN SS/ZZ	8	5	7	4.7	15	4.2x2.4x2.3	17	24	14.3	6.5	8	12	M2x2.5	1.2	1.6	2.8	890	1440	5.2	3.3	3.3	8	215	MR 7MN SS/ZZ
MR 5ML SS/ZZ	6	3.5	5	3.5	15	3.5x2.4x1	12	19.6	13.5	4.5	7	-	M2.6x2.0	0.7	1.3	2	470	900	2.4	2.1	2.1	4	116	MR 5ML SS/ZZ
MR 5MN SS/ZZ	6	3.5	5	3.5	15	3.5x2.4x1	12	16	10	4.5	-	8	M2x1.5	0.7	1.3	2	335	550	1.7	1	1	3.5	116	MR 5MN SS/ZZ
MRU 3ML SS	4	2.5	3	2.6	10	M1.6	8	16	11	3	5.5	-	M2x1.1	0.3	0.7	1.5	295	575	0.9	1.1	1.1	1.2	53	MRU 3ML SS
MRU 3MN SS	4	2.5	3	2.6	10	M1.6	8	11.7	6.8	3	3.5	-	M1.6x1.1	0.3	0.7	1.5	190	310	0.6	0.4	0.4	0.9	53	MRU 3MN SS

Load capacities are calculated according to ISO 14728. To compare the rating life definition and the load capacities: $C_{508} = 1.26 \times C_{1008}$

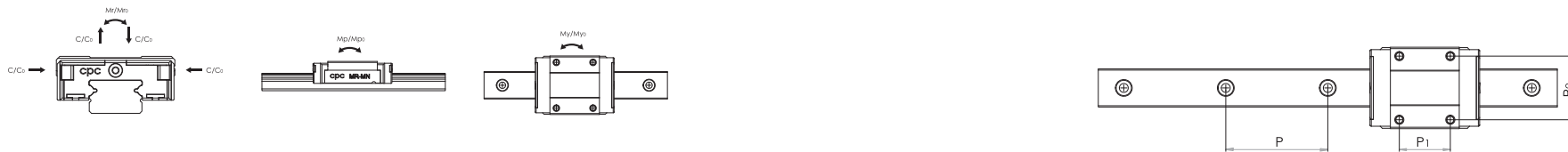

5. Dimensions and Specifications

5.3 MR-M SUE Series (End seal, Bottom Seal, Reinforcement Plate)

MR-M ZUE Series (End seal, Bottom Seal , Reinforcement Plate , Lubrication Storage)

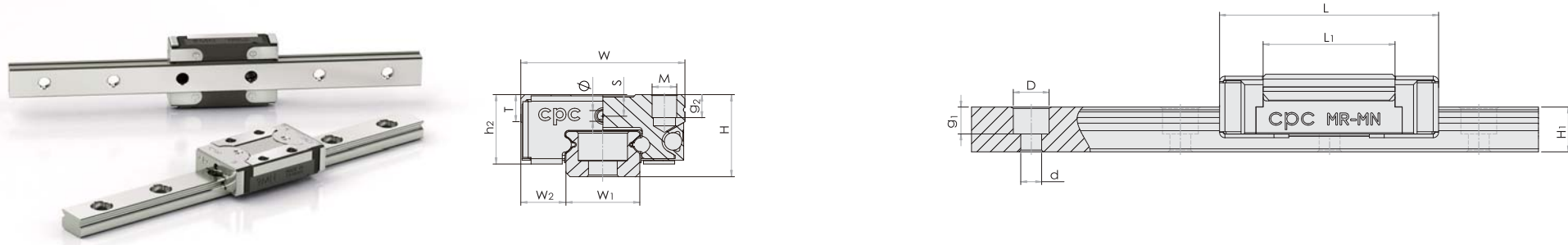

Model Code	Fabricate Dimensions		Rail Dimension(mm)				Block Dimension(mm)						Block Dimension(mm)				Load Capacities(N)		Static Moment(Nm)			Weight		Model Code
	H	W2	W1	H1	P	D x d x g1	W	L	L1	h2	P1	P2	M x g2	Ø	S	T	C1008 (dyn)	Co (stat)	Mr0	Mp0	My0	Block(g)	Rail(g/m)	
MR 15ML SUE/ZUE	16	8.5	15	9.5	40	6x3.5x4.5	32	61.6	44	13.1	25	25	M3x5.5	1.8	3.3	4.3	5350	9080	70	63.3	63.3	90	930	MR 15ML SUE/ZUE
MR 15MN SUE/ZUE	16	8.5	15	9.5	40	6x3.5x4.5	32	44.6	27	13.1	20	25	M3x5.5	1.8	3.3	4.3	3810	5590	43.6	27	27	61	930	MR 15MN SUE/ZUE
MR 12ML SUE/ZUE	13	7.5	12	7.5	25	6x3.5x4.5	27	49	34	10.9	20	20	M3x3.5	1.3	3.2	4.3	3240	5630	34.9	30.2	30.2	51	602	MR 12ML SUE/ZUE
MR 12MN SUE/ZUE	13	7.5	12	7.5	25	6x3.5x4.5	27	36.8	22	10.9	15	20	M3x3.5	1.3	3.2	4.3	2308	3465	21.5	12.9	12.9	34	602	MR 12MN SUE/ZUE
MR 9ML SUE/ZUE	10	5.5	9	5.5	20	6x3.5x3.5	20	41.9	30.8	8.5	16	15	M3x3.0	1.3	2.2	3.3	2135	3880	18.2	12.4	12.4	28	301	MR 9ML SUE/ZUE
MR 9MN SUE/ZUE	10	5.5	9	5.5	20	6x3.5x3.5	20	31.6	20.5	8.5	10	15	M3x3.0	1.3	2.2	3.3	1570	2495	11.7	6.4	6.4	18	301	MR 9MN SUE/ZUE
MR 5ML SUE/ZUE	6	3.5	5	3.5	15	3.5x2.4x1	12	20.2	13.5	5.0	7	-	M2.6x2.0	0.7	1.3	2	470	900	2.4	2.1	2.1	4	116	MR 5ML SUE/ZUE
MR 5MN SUE/ZUE	6	3.5	5	3.5	15	3.5x2.4x1	12	16.6	10	5.0	-	8	M2x1.5	0.7	1.3	2	335	550	1.7	1	1	3.5	116	MR 5MN SUE/ZUE

Load capacities are calculated according to ISO 14728. To compare the rating life definition and the load capacities: $C_{508} = 1.26 \times C_{1008}$

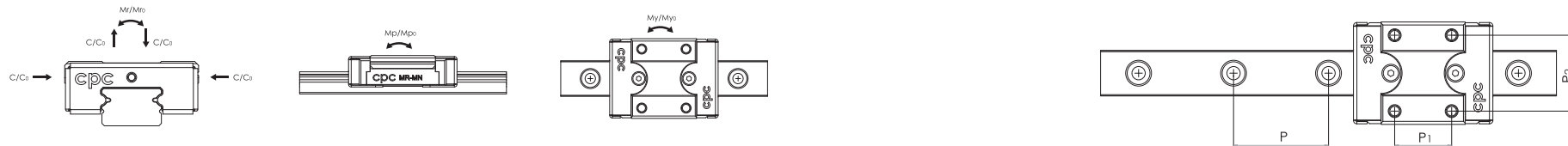

5. Dimensions and Specifications

5.4 MR-M EE Series (End seal, Reinforcement Plate)

MR-M EZ Series (End seal , Reinforcement Plate , Lubrication Storage)

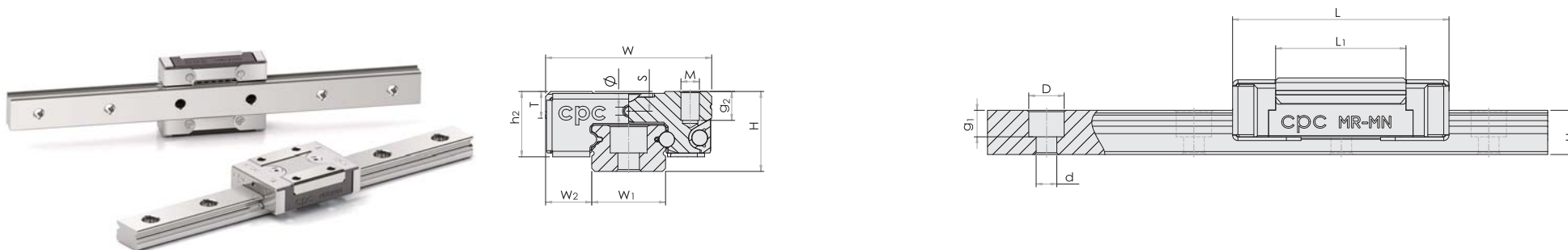

Model Code	Fabricate Dimensions		Rail Dimension(mm)					Block Dimension(mm)					Block Dimension(mm)				Load Capacities(N)		Static Moment(Nm)			Weight		Model Code
	H	W ₂	W ₁	H ₁	P	D x d x g ₁	W	L	L ₁	h ₂	P ₁	P ₂	M x g ₂	∅	S	T	C ₁₀₀₈ (dyn)	C ₀ (stat)	M _{r0}	M _{p0}	M _{y0}	Block(g)	Rail(g/m)	
MR 15ML EE/EZ	16	8.5	15	9.5	40	6x3.5x4.5	32	61.6	44	12.8	25	25	M3x5.5	1.8	3.3	4.3	5350	9080	70	63.3	63.3	90	930	MR 15ML EE/EZ
MR 15MN EE/EZ	16	8.5	15	9.5	40	6x3.5x4.5	32	44.6	27	12.8	20	25	M3x5.5	1.8	3.3	4.3	3810	5590	43.6	27	27	61	930	MR 15MN EE/EZ
MR 12ML EE/EZ	13	7.5	12	7.5	25	6x3.5x4.5	27	49	34	10.7	20	20	M3x3.5	1.3	3.2	4.3	3240	5630	34.9	30.2	30.2	51	602	MR 12ML EE/EZ
MR 12MN EE/EZ	13	7.5	12	7.5	25	6x3.5x4.5	27	36.8	22	10.7	15	20	M3x3.5	1.3	3.2	4.3	2308	3465	21.5	12.9	12.9	34	602	MR 12MN EE/EZ
MR 9ML EE/EZ	10	5.5	9	5.5	20	6x3.5x3.5	20	41.9	30.8	8.3	16	15	M3x3.0	1.3	2.2	3.3	2135	3880	18.2	12.4	12.4	28	301	MR 9ML EE/EZ
MR 9MN EE/EZ	10	5.5	9	5.5	20	6x3.5x3.5	20	31.6	20.5	8.3	10	15	M3x3.0	1.3	2.2	3.3	1570	2495	11.7	6.4	6.4	18	301	MR 9MN EE/EZ
MR 5ML EE/EZ	6	3.5	5	3.5	15	3.5x2.4x1	12	20.2	13.5	4.9	7	-	M2.6x2.0	0.7	1.3	2	470	900	2.4	2.1	2.1	4	116	MR 5ML EE/EZ
MR 5MN EE/EZ	6	3.5	5	3.5	15	3.5x2.4x1	12	16.6	10	4.9	-	8	M2x1.5	0.7	1.3	2	335	550	1.7	1	1	3.5	116	MR 5MN EE/EZ

* Anticipated

Load capacities are calculated according to ISO 14728. To compare the rating life definition and the load capacities: C₅₀₈=1.26xC₁₀₀₈

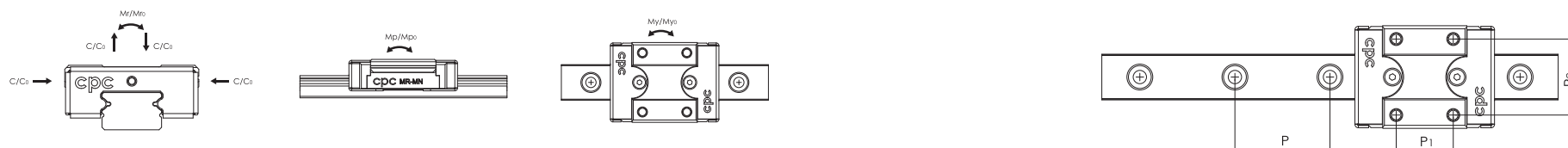

5. Dimensions and Specifications

5.5 MR-M EU Series (End seal , Reinforcement Plate , Stainless Bottom Seal)

MR-M UZ Series (End seal , Reinforcement Plate , Stainless Bottom Seal ,
Lubrication Storage)

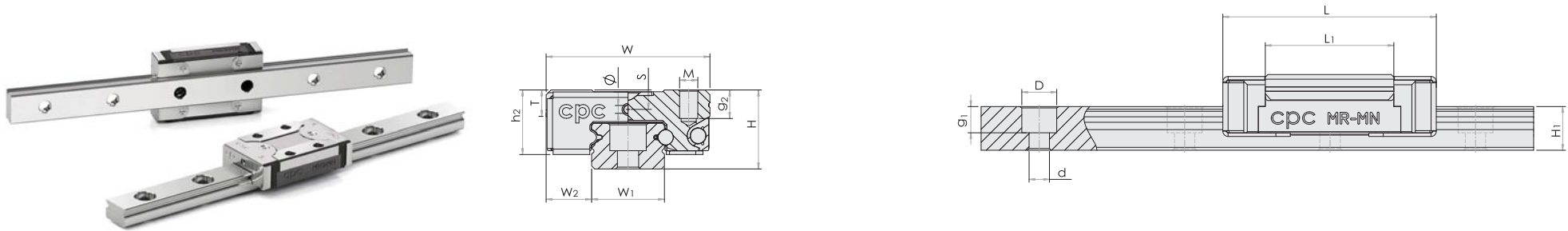

Model Code	Fabricate Dimensions		Rail Dimension(mm)				Block Dimension(mm)						Block Dimension(mm)				Load Capacities(N)		Static Moment(Nm)			Weight		Model Code
	H	W2	W1	H1	P	D x d x g 1	W	L	L1	h2	P1	P2	M x g2	Ø	S	T	C1008 (dyn)	C0 (stat)	Mr0	Mp0	My0	Block(g)	Rail(g/m)	
MR 15ML EU/UZ	16	8.5	15	9.5	40	6x3.5x4.5	32	61.6	44	13.1	25	25	M3x5.5	1.8	3.3	4.3	5350	9080	70	63.3	63.3	90	930	MR 15ML EU/UZ
MR 15MN EU/UZ	16	8.5	15	9.5	40	6x3.5x4.5	32	44.6	27	13.1	20	25	M3x5.5	1.8	3.3	4.3	3810	5590	43.6	27	27	61	930	MR 15MN EU/UZ
MR 12ML EU/UZ	13	7.5	12	7.5	25	6x3.5x4.5	27	49	34	11	20	20	M3x3.5	1.3	3.2	4.3	3240	5630	34.9	30.2	30.2	51	602	MR 12ML EU/UZ
MR 12MN EU/UZ	13	7.5	12	7.5	25	6x3.5x4.5	27	36.8	22	11	15	20	M3x3.5	1.3	3.2	4.3	2308	3465	21.5	12.9	12.9	34	602	MR 12MN EU/UZ
MR 9ML EU/UZ	10	5.5	9	5.5	20	6x3.5x3.5	20	41.9	30.8	8.6	16	15	M3x3.0	1.3	2.2	3.3	2135	3880	18.2	12.4	12.4	28	301	MR 9ML EU/UZ
MR 9MN EU/UZ	10	5.5	9	5.5	20	6x3.5x3.5	20	31.6	20.5	8.6	10	15	M3x3.0	1.3	2.2	3.3	1570	2495	11.7	6.4	6.4	18	301	MR 9MN EU/UZ

Load capacities are calculated according to ISO 14728. To compare the rating life definition and the load capacities: $C_{508} = 1.26 \times C_{1008}$

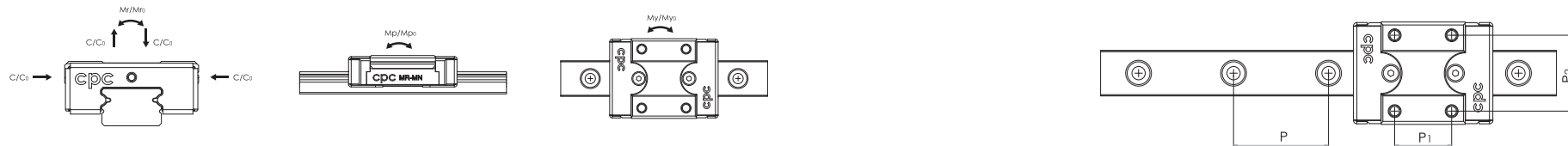

5. Dimensions and Specifications

5.6 MR-W SU Series (End seal , Bottom Seal)

MR-W ZU Series (End seal , Bottom Seal , Lubrication Storage)

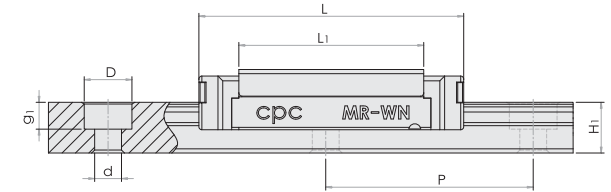
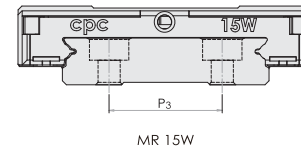
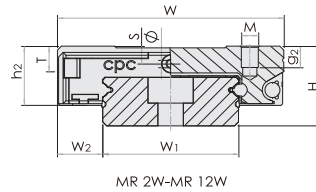

Model Code	Fabricate Dimensions		Rail Dimension(mm)				Block Dimension(mm)						Block Dimension(mm)				Load Capacities(N)		Static Moment(Nm)			Weight		Model Code	
	H	W ₂	W ₁	H ₁	P	P ₃	D x d x g ₁	W	L	L ₁	h ₂	P ₁	P ₂	M x g ₂	∅	S	T	C _{100B} (dyn)	C ₀ (stat)	M _{r0}	M _{p0}	M _{y0}	Block(g)		Rail(g/m)
MR 15WL SU/ZU	16	9	42	9.5	40	23	8x4.5x4.5	60	74.4	57.6	12.3	35	45	M4x4.5	1.8	3.3	4.5	6725	12580	257.6	93.1	93.1	200	2818	MR 15WL SU/ZU
MR 15WN SU/ZU	16	9	42	9.5	40	23	8x4.5x4.5	60	55.3	38.5	12.3	20	45	M4x4.5	1.8	3.3	4.5	5065	8385	171.1	45.7	45.7	137	2818	MR 15WN SU/ZU
MR 12WL SU/ZU	14	8	24	8.5	40	-	8x4.5x4.5	40	59.4	46	10.4	28	28	M3x3.5	1.3	3.1	4.5	4070	7800	95.6	56.4	56.4	93	1472	MR 12WL SU/ZU
MR 12WN SU/ZU	14	8	24	8.5	40	-	8x4.5x4.5	40	44.4	31	10.4	15	28	M3x3.5	1.3	3.1	4.5	3065	5200	63.7	26.3	26.3	65	1472	MR 12WN SU/ZU
MR 9WL SU/ZU	12	6	18	7.3	30	-	6x3.5x4.5	30	50.7	39.5	8.8	24	23	M3x3	1.3	2.6	4	2550	4990	45.9	26.7	26.7	51	940	MR 9WL SU/ZU
MR 9WN SU/ZU	12	6	18	7.3	30	-	6x3.5x4.5	30	39.1	27.9	8.8	12	21	M3x3	1.3	2.6	4	2030	3605	33.2	13.7	13.7	37	940	MR 9WN SU/ZU
MR 7WL SU/ZU	9	5.5	14	5.2	30	-	6x3.5x3.5	25	40.5	30.1	7.2	19	19	M3x3	1.1	1.9	3.2	1570	3140	22.65	14.9	14.9	27	516	MR 7WL SU/ZU
MR 7WN SU/ZU	9	5.5	14	5.2	30	-	6x3.5x3.5	25	31.6	21.2	7.2	10	19	M3x3	1.1	1.9	3.2	1180	2095	15	7.3	7.3	19	516	MR 7WN SU/ZU
MR 5WL SU/ZU	6.5	3.5	10	4	20	-	5.5x3x1.6	17	27.2	21.2	5.1	11	13	M2.5x1.5	0.9	1.2	2.3	615	1315	6.8	4.1	4.1	8	280	MR 5WL SU/ZU
MR 5WLC SU/ZU	6.5	3.5	10	4	20	-	5.5x3x1.6	17	27.2	21.2	5.1	11	13	M3/M2.5x1.5	0.9	1.2	2.3	615	1315	6.8	4.1	4.1	8	280	MR 5WLC SU/ZU
MR 5WN SU/ZU	6.5	3.5	10	4	20	-	5.5x3x1.6	17	21.1	15.1	5.1	6.5	13	M2.5x1.5	0.9	1.2	2.3	475	900	4.6	2.2	2.2	6	280	MR 5WN SU/ZU
MR 5WNC SU/ZU	6.5	3.5	10	4	20	-	5.5x3x1.6	17	21.1	15.1	5.1	6.5	13	M3/M2.5x1.5	0.9	1.2	2.3	475	900	4.6	2.2	2.2	6	280	MR 5WNC SU/ZU
* MR 3WL SU/ZU	4.5	3	6	2.7	15	-	4x2.4x1.5	12	20.1	15.1	3.6	8	-	M2x1.4	0.3	0.8	1.8	370	800	2.5	1.9	1.9	3.4	105	MR 3WL SU/ZU
* MR 3WN SU/ZU	4.5	3	6	2.7	15	-	4x2.4x1.5	12	15	10	3.6	4.5	-	M2x1.4	0.3	0.8	1.8	280	530	1.6	0.9	0.9	3.4	105	MR 3WN SU/ZU
* MR 2WL SU/ZU	4	3	4	3	10	-	2.8x1.8x1.0	10	17	11.9	3.1	6.5	-	M2x1.3	-	-	1.3	310	625	1.6	1.2	1.2	3.0	69	MR 2WL SU/ZU

* Anticipated

Load capacities are calculated according to ISO 14728. To compare the rating life definition and the load capacities: C_{50B}=1.26xC_{100B}

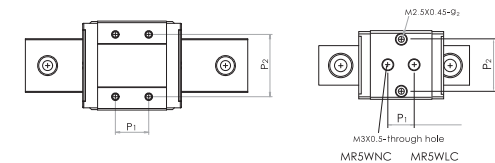
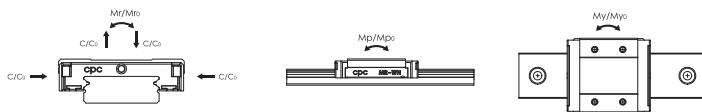

5. Dimensions and Specifications

5.7 MR-W SS Series (End seal)

MR-W ZZ Series (End seal , Lubrication Storage)

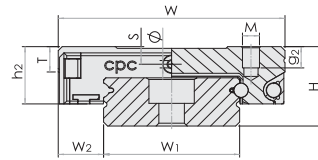

MR 2W-MR 12W

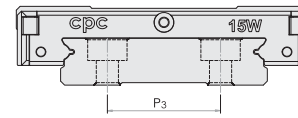

MR 15W

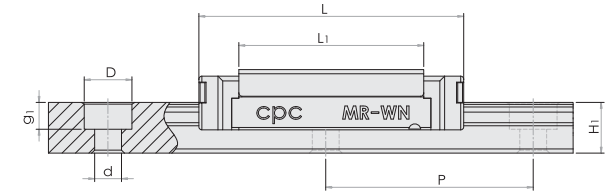

Model Code	Fabricate Dimensions		Rail Dimension(mm)				Block Dimension(mm)						Block Dimension(mm)				Load Capacities(N)		Static Moment(Nm)			Weight		Model Code	
	H	W2	W1	H1	P	P3	D x d x g1	W	L	L1	h2	P1	P2	M x g2	∅	S	T	C1008 (dyn)	Co (stat)	Mro	Mpo	Myo	Block(g)		Rail(g/m)
MR 15WL SS/ZZ	16	9	42	9.5	40	23	8x4.5x4.5	60	74.5	57.6	12	35	45	M4x4.5	1.9	3.3	4.5	6725	12580	257.6	93.1	93.1	200	2818	MR 15WL SS/ZZ
MR 15WN SS/ZZ	16	9	42	9.5	40	23	8x4.5x4.5	60	55.8	38.5	12	20	45	M4x4.5	1.9	3.3	4.5	5065	8385	171.1	45.7	45.7	137	2818	MR 15WN SS/ZZ
MR 12WL SS/ZZ	14	8	24	8.5	40	-	8x4.5x4.5	40	59.6	46	10.1	28	28	M3x3.5	1.4	3.1	4.5	4070	7800	95.6	56.4	56.4	93	1472	MR 12WL SS/ZZ
MR 12WN SS/ZZ	14	8	24	8.5	40	-	8x4.5x4.5	40	44.5	31.1	10.1	15	28	M3x3.5	1.4	3.1	4.5	3065	5200	63.7	26.3	26.3	65	1472	MR 12WN SS/ZZ
MR 9WL SS/ZZ	12	6	18	7.3	30	-	6x3.5x4.5	30	50.7	39.4	8.6	24	23	M3x3	1.3	2.6	4	2550	4990	45.9	26.7	26.7	51	940	MR 9WL SS/ZZ
MR 9WN SS/ZZ	12	6	18	7.3	30	-	6x3.5x4.5	30	39.1	27.9	8.6	12	21	M3x3	1.3	2.6	4	2030	3605	33.2	13.7	13.7	37	940	MR 9WN SS/ZZ
MR 7WL SS/ZZ	9	5.5	14	5.2	30	-	6x3.5x3.5	25	40.5	30.1	7	19	19	M3x3	1.1	1.9	3.2	1570	3140	22.65	14.9	14.9	27	516	MR 7WL SS/ZZ
MR 7WN SS/ZZ	9	5.5	14	5.2	30	-	6x3.5x3.5	25	31.8	21.2	7	10	19	M3x3	1.1	1.9	3.2	1180	2095	15	7.3	7.3	19	516	MR 7WN SS/ZZ
MR 5WL SS	6.5	3.5	10	4	20	-	5.5x3x1.6	17	27.2	21.2	5	11	13	M2.5x1.5	0.9	1.2	2.3	615	1315	6.8	4.1	4.1	8	280	MR 5WL SS
MR 5WLC SS	6.5	3.5	10	4	20	-	5.5x3x1.6	17	27.2	21.2	5	11	13	M3/M2.5x1.5	0.9	1.2	2.3	615	1315	6.8	4.1	4.1	8	280	MR 5WLC SS
MR 5WN SS	6.5	3.5	10	4	20	-	5.5x3x1.6	17	21.1	15.1	5	6.5	13	M2.5x1.5	0.9	1.2	2.3	475	900	4.6	2.2	2.2	6	280	MR 5WN SS
MR 5WNC SS	6.5	3.5	10	4	20	-	5.5x3x1.6	17	21.1	15.1	5	6.5	13	M3/M2.5x1.5	0.9	1.2	2.3	475	900	4.6	2.2	2.2	6	280	MR 5WNC SS
* MR 3WL SS/ZZ	4.5	3	6	2.7	15	-	4x2.4x1.5	12	20.1	15.1	3.5	8	-	M2x1.4	0.3	0.8	1.8	370	800	2.5	1.9	1.9	3.4	105	MR 3WL SS/ZZ
* MR 3WN SS/ZZ	4.5	3	6	2.7	15	-	4x2.4x1.5	12	15	10	3.5	4.5	-	M2x1.4	0.3	0.8	1.8	280	530	1.6	0.9	0.9	3.4	105	MR 3WN SS/ZZ
* MR 2WL SS/ZZ	4	3	4	3	10	-	2.8x1.8x1.0	10	17	11.9	3	6.5	-	M2x1.3	-	-	1.3	310	625	1.6	1.2	1.2	3.0	69	MR 2WL SS/ZZ

* Anticipated
Load capacities are calculated according to ISO 14728. To compare the rating life definition and the load capacities: C₅₀₈=1.26x C₁₀₀₈

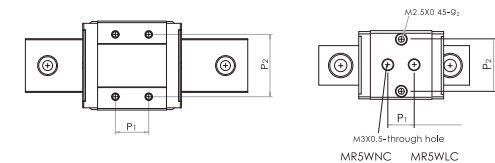
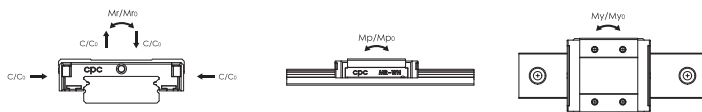

5. Dimensions and Specifications

5.8 MR-W SUE Series (End seal , Bottom Seal , Reinforcement Plate)

MR-W ZUE Series (End seal , Bottom Seal , Reinforcement Plate , Lubrication Storage)

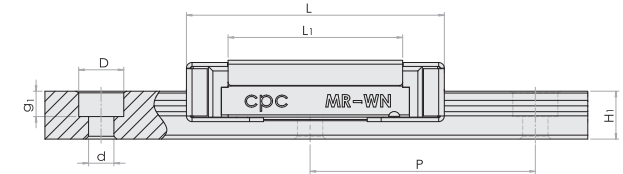
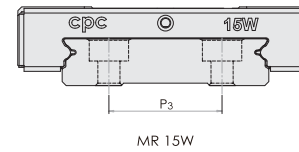
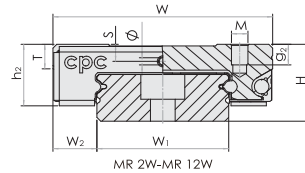

Model Code	Fabricate Dimensions		Rail Dimension(mm)					Block Dimension(mm)						Block Dimension(mm)				Load Capacities(N)		Static Moment(Nm)			Weight		Model Code
	H	W ₂	W ₁	H ₁	P	P ₃	D x d x g ₁	W	L	L ₁	h ₂	P ₁	P ₂	M x g ₂	Ø	S	T	C ₁₀₀₈ (dyn)	C ₀ (stat)	M _{r0}	M _{p0}	M _{y0}	Block(g)	Rail(g/m)	
MR 15WL SUE/ZUE	16	9	42	9.5	40	23	8x4.5x4.5	60	76	57.6	13.1	35	45	M4x4.5	1.8	3.3	4.5	6725	12580	257.6	93.1	93.1	203	2818	MR 15WL SUE/ZUE
MR 15WN SUE/ZUE	16	9	42	9.5	40	23	8x4.5x4.5	60	56.9	38.5	13.1	20	45	M4x4.5	1.8	3.3	4.5	5065	8385	171.1	45.7	45.7	140	2818	MR 15WN SUE/ZUE
MR 12WL SUE/ZUE	14	8	24	8.5	40	-	8x4.5x4.5	40	60.8	46	11.2	28	28	M3x3.5	1.3	3.1	4.5	4070	7800	95.6	56.4	56.4	96	1472	MR 12WL SUE/ZUE
MR 12WN SUE/ZUE	14	8	24	8.5	40	-	8x4.5x4.5	40	45.8	31	11.2	15	28	M3x3.5	1.3	3.1	4.5	3065	5200	63.7	26.3	26.3	68	1472	MR 12WN SUE/ZUE
MR 9WL SUE/ZUE	12	6	18	7.3	30	-	6x3.5x4.5	30	51.8	39.5	9.4	24	23	M3x3	1.3	2.6	4	2550	4990	45.9	26.7	26.7	51	940	MR 9WL SUE/ZUE
MR 9WN SUE/ZUE	12	6	18	7.3	30	-	6x3.5x4.5	30	40.2	27.9	9.4	12	21	M3x3	1.3	2.6	4	2030	3605	33.2	13.7	13.7	37	940	MR 9WN SUE/ZUE
MR 7WL SUE/ZUE	9	5.5	14	5.2	30	-	6x3.5x3.5	25	41.5	30.1	7.6	19	19	M3x3	1.1	1.9	3.2	1570	3140	22.65	14.9	14.9	27	516	MR 7WL SUE/ZUE
MR 7WN SUE/ZUE	9	5.5	14	5.2	30	-	6x3.5x3.5	25	32.5	21.2	7.6	10	19	M3x3	1.1	1.9	3.2	1180	2095	15	7.3	7.3	19	516	MR 7WN SUE/ZUE
MR 2WL SUE/ZUE	4	3	4	3	10	-	2.8x1.8x1.0	10	17.5	11.9	3.4	6.5	-	M2x1.3	-	-	1.3	310	625	1.6	1.2	1.2	3.0	69	MR 2WL SUE/ZUE

Load capacities are calculated according to ISO 14728. To compare the rating life definition and the load capacities: C₉₈=1.26xC₁₀₀₈

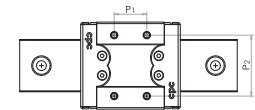
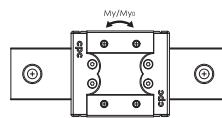
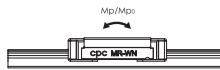
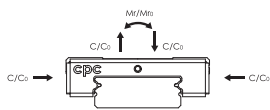

5. Dimensions and Specifications

5.9 MR-W EE Series (End seal, Reinforcement Plate)

MR-W EZ Series (End seal , Reinforcement Plate , Lubrication Storage)

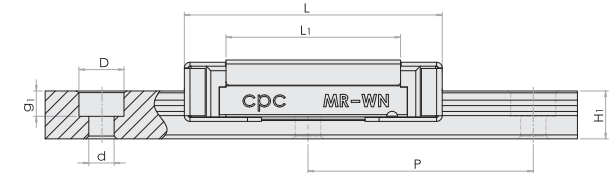
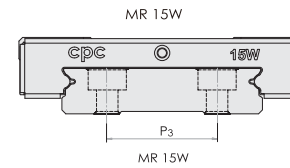
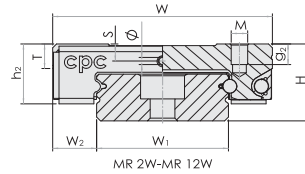

Model Code	Fabricate Dimensions		Rail Dimension(mm)				Block Dimension(mm)						Block Dimension(mm)				Load Capacities(N)		Static Moment(Nm)			Weight		Model Code	
	H	W2	W1	H1	P	P3	D x d x g1	W	L	Li	h2	P1	P2	M x g2	Ø	S	T	C1008 (dyn)	Co (stat)	Mr0	Mp0	My0	Block(g)		Rail(g/m)
MR 15WL EE/EZ	16	9	42	9.5	40	23	8x4.5x4.5	60	76	57.6	12.8	35	45	M4x4.5	1.8	3.3	4.5	6725	12580	257.6	93.1	93.1	203	2818	MR 15WL EE/EZ
MR 15WN EE/EZ	16	9	42	9.5	40	23	8x4.5x4.5	60	56.9	38.5	12.8	20	45	M4x4.5	1.8	3.3	4.5	5065	8385	171.1	45.7	45.7	140	2818	MR 15WN EE/EZ
MR 12WL EE/EZ	14	8	24	8.5	40	-	8x4.5x4.5	40	60.8	46	10.9	28	28	M3x3.5	1.3	3.1	4.5	4070	7800	95.6	56.4	56.4	96	1472	MR 12WL EE/EZ
MR 12WN EE/EZ	14	8	24	8.5	40	-	8x4.5x4.5	40	45.8	31	10.9	15	28	M3x3.5	1.3	3.1	4.5	3065	5200	63.7	26.3	26.3	68	1472	MR 12WN EE/EZ
MR 9WL EE/EZ	12	6	18	7.3	30	-	6x3.5x4.5	30	51.8	39.5	9.2	24	23	M3x3	1.3	2.6	4	2550	4990	45.9	26.7	26.7	51	940	MR 9WL EE/EZ
MR 9WN EE/EZ	12	6	18	7.3	30	-	6x3.5x4.5	30	40.2	27.9	9.2	12	21	M3x3	1.3	2.6	4	2030	3605	33.2	13.7	13.7	37	940	MR 9WN EE/EZ
MR 7WL EE/EZ	9	5.5	14	5.2	30	-	6x3.5x3.5	25	41.5	30.1	7.5	19	19	M3x3	1.1	1.9	3.2	1570	3140	22.65	14.9	14.9	27	516	MR 7WL EE/EZ
MR 7WN EE/EZ	9	5.5	14	5.2	30	-	6x3.5x3.5	25	32.5	21.2	7.5	10	19	M3x3	1.1	1.9	3.2	1180	2095	15	7.3	7.3	19	516	MR 7WN EE/EZ
MR 2WL EE/EZ	4	3	4	3	10	-	2.8x1.8x1.0	10	17.5	11.9	3.3	6.5	-	M2x1.3	-	-	1.3	310	625	1.6	1.2	1.2	3.0	69	MR 2WL EE/EZ

Load capacities are calculated according to ISO 14728. To compare the rating life definition and the load capacities: $C_{508} = 1.26 \times C_{1008}$

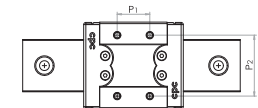
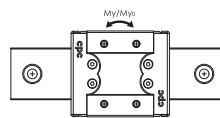
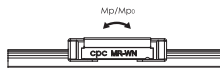
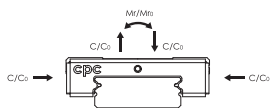

5. Dimensions and Specifications

5.10 MR-W EU Series (End seal , Reinforcement Plate , Stainless Bottom Seal)

MR-W UZ Series (End seal , Reinforcement Plate , Stainless Bottom Seal ,
Lubrication Storage)

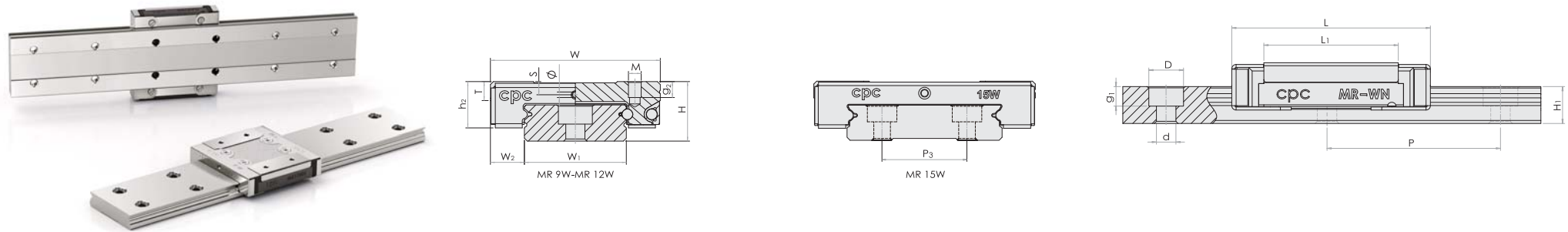

Model Code	Fabricate Dimensions		Rail Dimension(mm)				Block Dimension(mm)						Block Dimension(mm)				Load Capacities(N)		Static Moment(Nm)			Weight		Model Code	
	H	W ₂	W ₁	H ₁	P	P ₃	D x d x g ₁	W	L	L ₁	h ₂	P ₁	P ₂	M x g ₂	∅	S	T	C ₁₀₀₈ (dyn)	C ₀ (stat)	M _{r0}	M _{p0}	M _{y0}	Block(g)		Rail(g/m)
MR 15WL EU/UZ	16	9	42	9.5	40	23	8x4.5x4.5	60	76	57.6	13.1	35	45	M4x4.5	1.8	3.3	4.5	6725	12580	257.6	93.1	93.1	203	2818	MR 15WL EU/UZ
MR 15WN EU/UZ	16	9	42	9.5	40	23	8x4.5x4.5	60	56.9	38.5	13.1	20	45	M4x4.5	1.8	3.3	4.5	5065	8385	171.1	45.7	45.7	140	2818	MR 15WN EU/UZ
MR 12WL EU/UZ	14	8	24	8.5	40	-	8x4.5x4.5	40	60.8	46	11	28	28	M3x3.5	1.3	3.1	4.5	4070	7800	95.6	56.4	56.4	96	1472	MR 12WL EU/UZ
MR 12WN EU/UZ	14	8	24	8.5	40	-	8x4.5x4.5	40	45.8	31	11	15	28	M3x3.5	1.3	3.1	4.5	3065	5200	63.7	26.3	26.3	68	1472	MR 12WN EU/UZ
MR 9WL EU/UZ	12	6	18	7.3	30	-	6x3.5x4.5	30	51.8	39.5	9.5	24	23	M3x3	1.3	2.6	4	2550	4990	45.9	26.7	26.7	51	940	MR 9WL EU/UZ
MR 9WN EU/UZ	12	6	18	7.3	30	-	6x3.5x4.5	30	40.2	27.9	9.5	12	21	M3x3	1.3	2.6	4	2030	3605	33.2	13.7	13.7	37	940	MR 9WN EU/UZ

Load capacities are calculated according to ISO 14728. To compare the rating life definition and the load capacities: C₅₀₈=1.26xC₁₀₀₈



5. Dimensions and Specifications

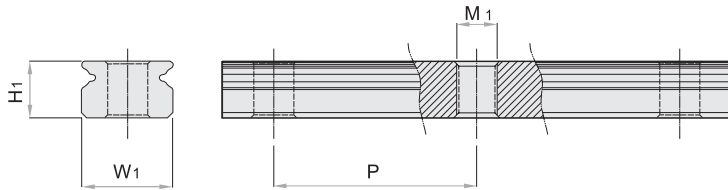

5.13 Standard MRU-M series - Tapped from bottom

Dimensions and Specifications

Model Code	Rail Dimensions (mm)			
	H ₁	W ₁	P	M ₁
MRU 15M	9.5	15	40	M4x0.7
MRU 12M	7.5	12	25	M4x0.7
MRU 9M	5.5	9	20	M4x0.7
MRU 7M	4.7	7	15	M3x0.5
MRU 5M	3.5	5	15	M3x0.5
MRU 3M	2.6	3	10	M1.6 x0.35

5.14 Wide MRU-W series - Tapped from bottom

Dimensions and Specifications

Model Code	Rail Dimensions (mm)			
	H ₁	W ₁	P	M ₁
MRU 15W	9.5	42	40	M5x0.8
MRU 12W	8.5	24	40	M5x0.8
MRU 9W	7.3	18	30	M4x0.7
MRU 7W	5.2	14	30	M4x0.7
MRU 5W	4	10	20	M3x0.5
MRU 3W	2.7	6	15	M3x0.5

6. Carbon Steel

Characteristic

1. Providing the max length: 3m.
2. Hardness of the ball runner rail surface : HRC 58 ~ 63
Hardness of the centre : About HRC 28
3. Applies to the industrial machine in normal condition.
4. Sizes are the same as stainless steel products.
5. With more competitive price.
6. Precision class available for N, H, and P Grade.
7. Product size, precision class, and other technical information are the same as MR stainless series, please refer to [cpc MR Miniature Linear Guide Series Catalog](#).

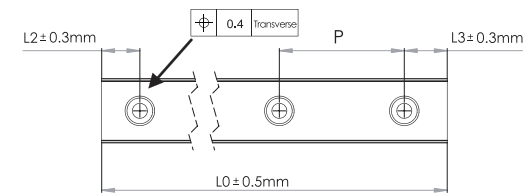
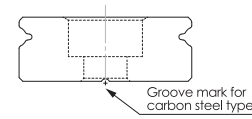

Suggestion length of one rail	Standard			Wide		
	9M	12M	15M	9W	12W	15W
Pitch (mm)	20	25	40	30	40	40
L2, L3 min	4	4	4	4	4	4
L2, L3 max	20	20	35	25	35	35
Lmax L0 (mm)	3000	3000	3000	3000	3000	3000

6. Carbon Steel

Standard Rail

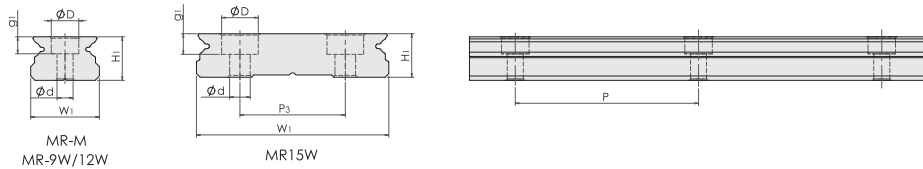

Standard MR-M series Rail

Model Code	Rail Dimensions(mm)				Weight(g/m)
	H1	W1	P	Dxdxg1	
MR 15M	9.5	15	40	6x3.5x4.5	930
MR 12M	7.5	12	25	6x3.5x4.5	602
MR 9M	5.5	9	20	6x3.5x3.5	301

Wide MR-W series Rail

Model Code	Rail Dimensions(mm)					Weight(g/m)
	H1	W1	P	P3	Dxdxg1	
MR 15W	9.5	42	40	23	8x4.5x4.5	2818
MR 12W	8.5	24	40	-	8x4.5x4.5	1472
MR 9W	7.3	18	30	-	6x3.5x4.5	940



ST Miniature Stroke Slide series

Tapped Rail

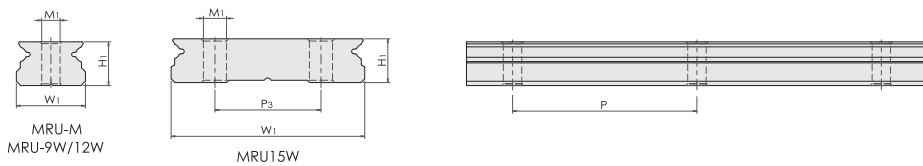

Standard MRU-M series - Tapped from bottom

Model Code	Rail Dimensions(mm)				Weight(g/m)
	H1	W1	P	M1	
MRU 15M	9.5	15	40	M4x0.7	930
MRU 12M	7.5	12	25	M4x0.7	602
MRU 9M	5.5	9	20	M4x0.7	301

Wide MRU-W series - Tapped from bottom

Model Code	Rail Dimensions(mm)					Weight(g/m)
	H1	W1	P	P3	M1	
MRU 15W	9.5	42	40	23	M5x0.8	2818
MRU 12W	8.5	24	40	-	M5x0.8	1472
MRU 9W	7.3	18	30	-	M4x0.7	940

1. Product Introduction

High load and high moment capacity

The ST Miniature Stroke Slide series is designed with two rows of balls. The ball track has a Gothic profile design with a 45 degree contact angle to achieve equal load capacity in a mono block. This provides more space for the larger rolling elements while enhancing the load and moment capacity.

High running accuracy and smoothness

The steel balls of the ST Miniature Stroke Slide series roll on the rail without recirculation, resulting in excellent running behavior, smoothness, low friction, and high accuracy without vibration.

Dual plate design

The ST Miniature Stroke Slide series adopts a pair of end plates into the design. Both the center rail and bearing block sides have a plate installed that prevents the linear guide from over-stroking.

Easy mounting

The mounting of the ST Miniature Stroke Slide series is accomplished by fitting the fixing screw downward into the count bore of the rail by intersecting the bore pattern on the block and cage within a hole pitch. The one piece cage therefore does not influence the mounting of the rail. The preload is preset by ball sorting.



Temperature

The ST Miniature Stroke Slide series can withstand temperatures up to 150°C. There are two treatment options for higher temperature applications:

T1 : 200°C
T2 : 300°C

Applying treatments for higher temperature applications will reduce the load capacity.

Anti-corrosion feature

The ST Miniature Stroke Slide series is composed of quenched hardened process stainless steel for the rail, block, and steel balls. The block plate and screw are made of stainless steel as well -- great for maintenance and inspection applications.

2. Technical Information

Accuracy

The ST Miniature Stroke Slide series have three grades for accuracy. Precision (P), High (H) and Normal (N).

Preload

The ST Miniature Stroke Slide series have two classes of preload, V0 and V1, as described in the MR miniature linear guide series table of preload.

Geometric and positional accuracy of the mounting surface

The inaccuracy of the mounting surfaces will affect the running accuracy and reduce the operating lifetime of the ST Miniature Stroke Slide. If the inaccuracies of the mounting surface exceed the values calculated by formulas (15), (21), and (17), the lifetime will be shortened, as calculated by formulas (19) and (20).

$$e_{1(mm)} = b_{(mm)} \cdot f_1 \cdot 10^{-4} \quad \text{--- (15)}$$

$$e_{2(mm)} = \left(\frac{d}{L_C} \right)_{(mm)} \cdot f_2 \cdot 10^{-5} \quad \text{--- (21)}$$

$$e_{3(mm)} = f_3 \cdot 10^{-3} \quad \text{--- (17)}$$

Rating life calculation

$$L = K_{st} \left(\frac{C_{1008}}{P} \right)^3 \cdot 10^5 \quad \text{--- (19)}$$

$$L_h = \frac{L}{2 \cdot s \cdot n \cdot 60} = K_{st} \cdot \frac{L}{v_m \cdot 60} \quad \text{--- (20)}$$

Short stroke factor diagram

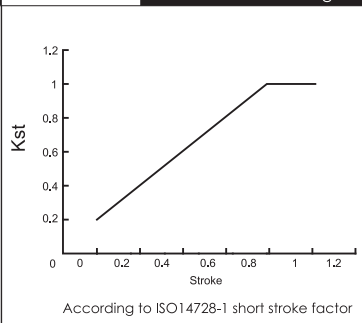

The mounting surface geometric and positional accuracy factor

Size	V0			V1		
	f ₁	f ₂	f ₃	f ₁	f ₂	f ₃
7	5	200	4	3	130	3
9	5	300	6	4	200	4
12	6	380	8	4	250	6
15	7	530	12	5	350	8

Ordering designation

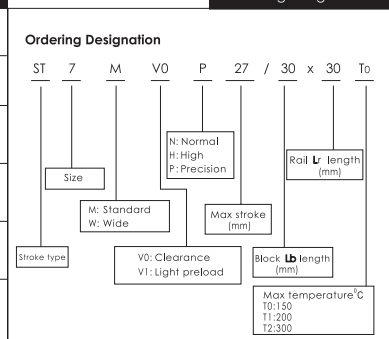

Lubrication

Lubrication of the ST Miniature Stroke Slide series can be done by adding the lubricant onto the raceway of the rail.

Rating life L

The rating life of the ST Miniature Stroke Slide series can be calculated by the formulas (19) , (20) in accordance with ISO 14728-1.

Height and chamfered reference edge

The tables for the chamfered reference edge corner and the height of the reference edge for the MR Miniature Linear Guide series are also suitable for the ST Miniature Stroke Slide series.

3. Ordering Information

An example of the ST Miniature Stroke Slide series parts numbering system is shown above.

4. Dimensions and Specifications

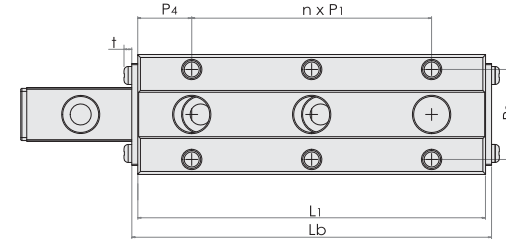
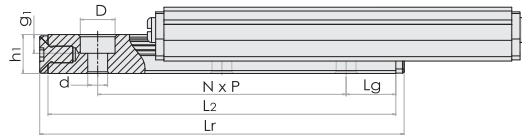
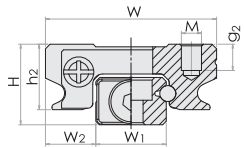

Model Code	Fabricate Dimensions (mm)		Rail Dimensions (mm)				Block Dimensions (mm)						Model Code
	H	W ₂	P	W ₁	h ₁	D x d x g ₁	P ₁	P ₂	W	h ₂	M x g ₂	t	
ST7M	8	5	15	7	4.7	4.2x2.4x2.3	15	12	17	6.5	M2x2.5	1	ST7M
ST9M	10	5.5	20	9	5.5	6x3.5x3.5	20	15	20	7.8	M3x3.0	1.3	ST9M
ST12M	13	7.5	25	12	7.5	6x3.5x4.5	25	20	27	10	M3x3.5	1.3	ST12M

Model Code	Max Stroke	Rail Dimensions (mm)				Block Dimensions (mm)				Load Capacities		Static Moment		
	L _s	L _r	L ₂	L _g	N	L _b	L ₁	P ₄	n	C ₁₀₀₈ (dyn)	C ₀ (stat)	M _{r0}	M _{p0}	M _{y0}
ST7M	27	30	28	6.5	1	30	28	6.5	1	910	1580	5.9	3.4	3.4
ST7M	41	45	43	6.5	2	45	43	6.5	2	1220	2500	9.1	8	8
ST7M	55	60	58	6.5	3	60	58	6.5	3	1490	3330	12.4	14.6	14.6
ST9M	38	40	38	9	1	40	38	9	1	1590	2773	13.1	6.8	6.8
ST9M	58	60	58	9	2	60	58	9	2	2080	4170	19.7	16	16
ST9M	78	80	78	9	3	80	78	9	3	2520	5547	26.2	29.2	29.2
ST12M	44	50	47.4	11.2	1	50	47.4	11.2	1	2550	4340	27	16	16
ST12M	69	75	72.4	11.2	2	75	72.4	11.2	2	3350	6510	40.1	35.6	35.6
ST12M	94	100	97.4	11.2	3	100	97.4	11.2	3	4050	8670	54	62.8	62.8

cpc AR/HR Z Series Lubrication Storage Pad Testing Report

A linear guide is a category of rolling guidance. By using unlimited recirculating stainless steel balls operating between the raceways of the rail and the runner block, the carriage achieves high precision and low friction linear movement. If the linear guides do not have sufficient lubrication, rolling friction will increase, causing wear and shortened linear guide life span.

cpc has added and embedded PU lubricant storage pads to prolong the life of the linear guide; the pads directly contact and lubricate the rolling balls. This design supplies sufficient lubrication even in short stroke operations.

cpc's design, due to the embedded pad's absorption and retention capabilities, results in a product that features a long operational life and long-term lubrication.

The following are the results of cpc's in-house testing.

AR15 Lubrication Storage Pad Testing Data

Tested products: AR15 blocks with lubrication storage pads, 8 pieces, and AR15 rails, N accuracy grade, 1500mm Length, 4 pieces

Testing condition	
Rating load capacities(each Block)	1.8KN(C=9KN · C0=17.5KN)
Stroke	0.96m
Max running speed	1m/s
Lubricant	DAPHNE SUPER MULTI 68 (Viscosity64.32 CST 400C)
Lubrication period	No lubrication added during testing period

■ Testing equipment



■ Testing result

Dried lubricant residue started appearing on rail profile, PU pads, and ball retainer of the tested blocks

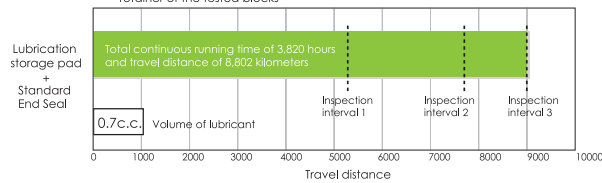

■ Test results at inspection intervals

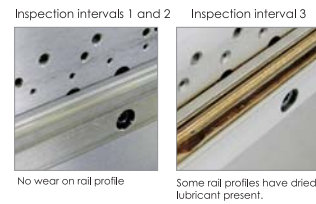

Inspection intervals 1 and 2: Lubrication Maintained



- Upward lubrication storage pads in good condition.
- Lubricant supply in good condition.
- No wear on the running profile of the rail.
- Downward lubrication storage pads in good condition.
- Lubricant supply in good condition.

Inspection interval 3: Lubricant residue



- Dried lubricant residue started appearing broken on the upward lubrication storage pads from the tested blocks.
- Dried lubricant residue started appearing broken on the downward lubrication storage pads from the tested blocks.

Plastic parts and end seal in good condition



Plastic parts in good condition End seal in good condition

■ Test Summary

Total continuous running time of 3820 hours and travel distance of 8802 kilometers.

Out of eight test blocks, dried lubricant residue appeared on 2 blocks and 1 rail. Dried lubricant residue is indicative of a need for re-lubrication.

The test results indicate that the lubrication pad design effectively extends the time between re-lubrication and thus lengthens the operational life of the linear guide.



linear motion technology
cpc cnc automation co., ltd.



linear motion technology
cpc cnc automation co., ltd.